

FKWT/LED

Aktor-/Sensor-Anschlussleitung, FIXCON-Winkelkupplung mit LED-Betriebs- und Funktionsanzeige, rüttelsicherer Verriegelungshülse und angespritztem Kabel

Actuator/sensor cordset, single-ended, FIXCON female right angle connector with LED operation and function indicator, vibration-proof locking sleeve and molded cable

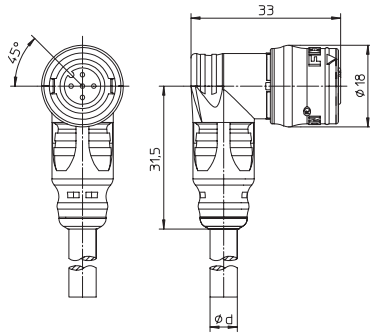

FIXCON®

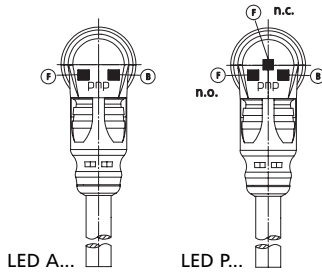

- B Betriebsanzeige grün
operation indicator green
- F Funktionsanzeige gelb
function indicator yellow

Pinbelegung Pin assignment

3-polig 3 poles



- 1 = braun / brown
- 2 = n.c.
- 3 = blau / blue
- 4 = schwarz / black

4-polig 4 poles



- 1 = braun / brown
- 2 = weiß / white
- 3 = blau / blue
- 4 = schwarz / black

Schaltbild Wiring diagram

A pnp-Schließer / pnp Normally open = gelb-grün / yellow-green

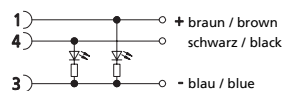

P pnp-Öffner-/Schließer / pnp-Normally closed/open = gelb-gelb-grün (Antivalent) / yellow-yellow-green

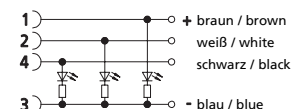









Sonderbeschaltungen auf Anfrage / Special circuits on request

Anschlussleitungen für Aktoren, Sensoren und Verteiler Cordsets, single-ended, for actuators, sensors and distribution boxes

Technische Daten	
Umgebungstemperatur	-25°C / +80°C
Werkstoffe	
Gehäuse / Griffkörper	TPU, selbstverlöschend
Kontaktträger	TPU, selbstverlöschend
Kontakt	CuZn, unternickelt und 0,8 µm vergoldet
Gewindebuchse / Rändelschraube/-mutter / Sechskantschraube/-mutter / Hülse	GD-Zn, vernickelt
Mechanische Daten	
Schutzart	IP 67 Nur im verriegelten Zustand mit den dazugehörigen Gegenstücken.
Elektrische Daten	
Durchgangswiderstand	≤ 5 mΩ
Nennstrom bei 40°C	4 A
Nennspannung	10–30 V DC
Bemessungsspannung	63 V
Isolationswiderstand	> 10 ⁹ Ω
Verschmutzungsgrad	3

Technical data	
Operating temperature range	-25°C / +80°C
Materials	
Housing / Molded body	TPU, self-extinguishing
Insert	TPU, self-extinguishing
Contact	CuZn, pre-nickelated and 0.8 microns gold-plated
Receptacle shell / knurled screw/nut / hexagon screw/nut / sleeve	GD-Zn, nickel-plated
Mechanical data	
Degree of protection	IP 67 Only in locked position with its proper counterparts.
Electrical data	
Contact resistance	≤ 5 mΩ
Nominal current at 40°C	4 A
Nominal voltage	10–30 V DC
Rated voltage	63 V
Insulation resistance	> 10 ⁹ Ω
Pollution degree	3

Bestellbezeichnung Designation	Polzahl Poles	Mantel Outer jacket	
FKWT/LED A 4-3-224/... M	3	PUR halogenfrei / halogen free	  
FKWT/LED A 4-3-294/... M		PVC	
FKWT/LED P 4-225/... M	4	PUR halogenfrei / halogen free	  
FKWT/LED P 4-295/... M		PVC	
Standardlängen: 2 M / 5 M / 10 M Andere Kabellängen oder Leitungsaufbauten auf Anfrage.		Standard lengths: 2 M / 5 M / 10 M Other cable lengths or cable specifications on request.	