

FKT

Aktor-/Sensor-Anschlussleitung, FIXCON-Kupplung mit rüttelsicherer Verriegelungshülse und angespritztem Kabel

Actuator/sensor cordset, single-ended, FIXCON female connector with vibration-proof locking sleeve and molded cable

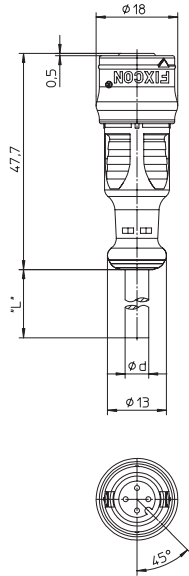

FIXCON®

FKWT

Aktor-/Sensor-Anschlussleitung, FIXCON-Winkelkupplung mit rüttelsicherer Verriegelungshülse und angespritztem Kabel

Actuator/sensor cordset, single-ended, FIXCON female right angle connector with vibration-proof locking sleeve and molded cable

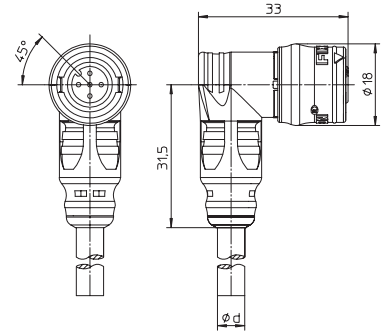

FIXCON®

Pinbelegung
Pin assignment

3-polig
3 poles



- 1 = braun / brown
- 2 = n.c.
- 3 = blau / blue
- 4 = schwarz / black

4-polig
4 poles



- 1 = braun / brown
- 2 = weiß / white
- 3 = blau / blue
- 4 = schwarz / black













5-polig
5 poles



- 1 = braun / brown
- 2 = weiß / white
- 3 = blau / blue
- 4 = schwarz / black
- 5 = grün/gelb / green/yellow (FK(W)T 5-56/...M = grau/grey)

Anschlussleitungen für Aktoren, Sensoren und Verteiler Cordsets, single-ended, for actuators, sensors and distribution boxes

Technische Daten		Technical data	
Umgebungstemperatur	-25°C / +80°C	Operating temperature range	-25°C / +80°C
Werkstoffe		Materials	
Gehäuse / Griffkörper	TPU, selbstverlöschend	Housing / Molded body	TPU, self-extinguishing
Kontaktträger	TPU, selbstverlöschend	Insert	TPU, self-extinguishing
Kontakt	CuZn, unternickelt und 0,3 µm vergoldet	Contact	CuZn, pre-nickel- and 0.3 microns gold-plated
Gewindebuchse / Rändelschraube/-mutter / Sechskantschraube/-mutter / Hülse	GD-Zn, vernickelt	Receptacle shell / knurled screw/nut / hexagon screw/nut / sleeve	GD-Zn, nickel-plated
Mechanische Daten		Mechanical data	
Schutzart	IP 67 Nur im verriegelten Zustand mit den dazugehörigen Gegenstücken.	Degree of protection	IP 67 Only in locked position with its proper counterparts.
Elektrische Daten		Electrical data	
Durchgangswiderstand	≤ 5 mΩ	Contact resistance	≤ 5 mΩ
Nennstrom bei 40°C	4 A	Nominal current at 40°C	4 A
Nennspannung	3- bis 4-polig 240 V 5-polig 60 V	Nominal voltage	3-4 poles 240 V 5 poles 60 V
Bemessungsspannung	3- bis 4-polig 250 V 5-polig 63 V	Rated voltage	3-4 poles 250 V 5 poles 63 V
Prüfspannung	3- bis 4-polig 2,0 kV eff. / 60 s 5-polig 1,5 kV eff. / 60 s	Test voltage	3-4 poles 2.0 kV eff. / 60 s 5 poles 1.5 kV eff. / 60 s
Isolationswiderstand	> 10 ⁹ Ω	Insulation resistance	> 10 ⁹ Ω
Verschmutzungsgrad	3	Pollution degree	3

Bestellbezeichnung Designation		Polzahl Poles	Mantel Outer jacket	
FKT 4-3-224/... M	FKWT 4-3-224/... M	3	PUR halogenfrei / halogen free	  
FKT 4-3-294/... M	FKWT 4-3-294/... M		PVC	
FKT 4-225/... M	FKWT 4-225/... M	4	PUR halogenfrei / halogen free	  
FKT 4-295/... M	FKWT 4-295/... M		PVC	
FKT 5-228/... M	FKWT 5-228/... M	5	PUR halogenfrei / halogen free	  
FKT 5-296/... M	FKWT 5-296/... M		PVC	

Standardlängen: 2 M / 5 M / 10 M Standard lengths: 2 M / 5 M / 10 M
Andere Kabellängen oder Leitungsaufbauten auf Anfrage. Other cable lengths or cable specifications on request.